

AVAILABLE WITH ONE OR TWO SPEEDS

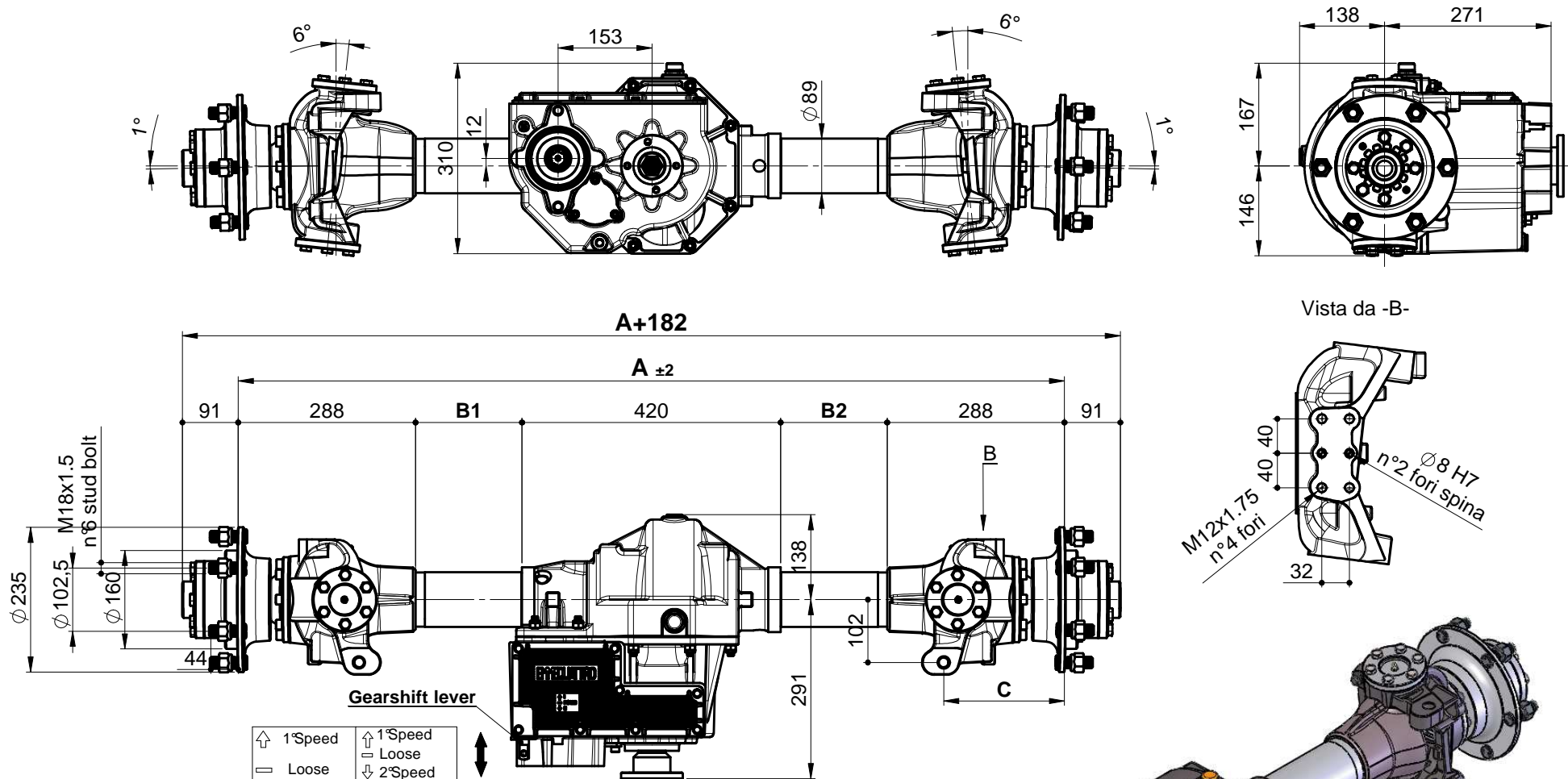

TECHNICAL DATA

Max allowable axle load	24000	N
Max wheel torque	3200	Nm
Max steering angle	-	
Axle ratio	-	
Gear box	1 st speed ratio	1:31.21
	2 nd speed ratio	1:7.71 / 1:12.16
Input max rpm	5000	rpm
Min track width	1200	mm
Max track width	1600	mm

OPTIONAL

See attachments