

ALE106.P0020

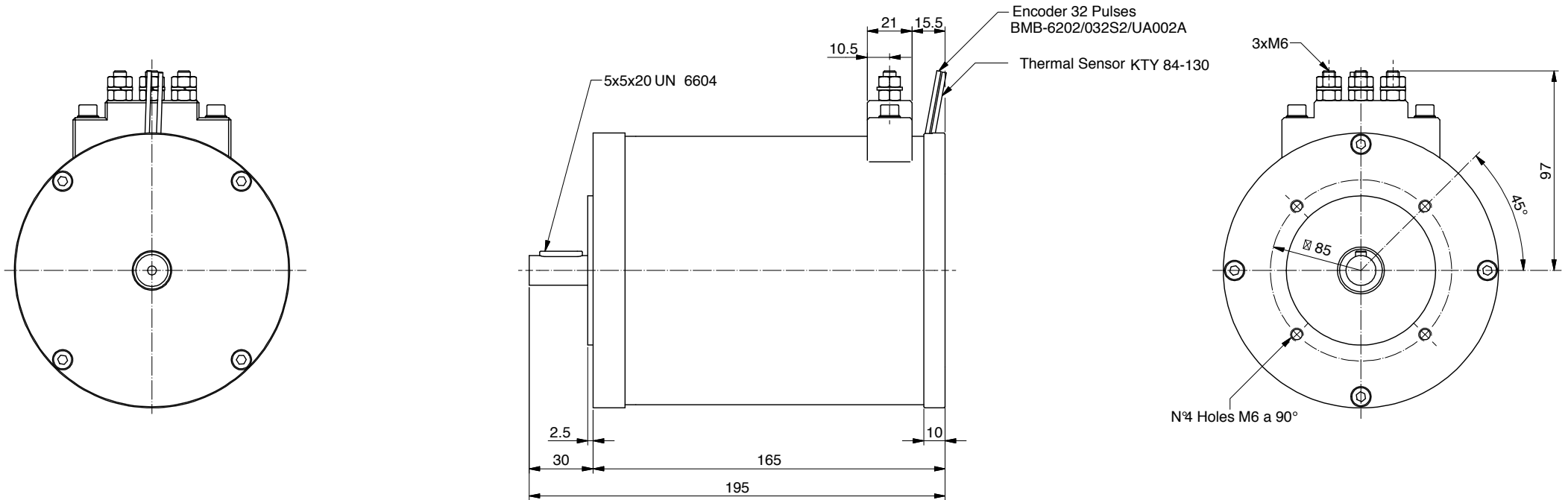

Power	600 W
Tension	24 V
Speed	2850 Rpm
Torque	2.0 Nm
Enclosure	IP 23

