

ALE200.P0018

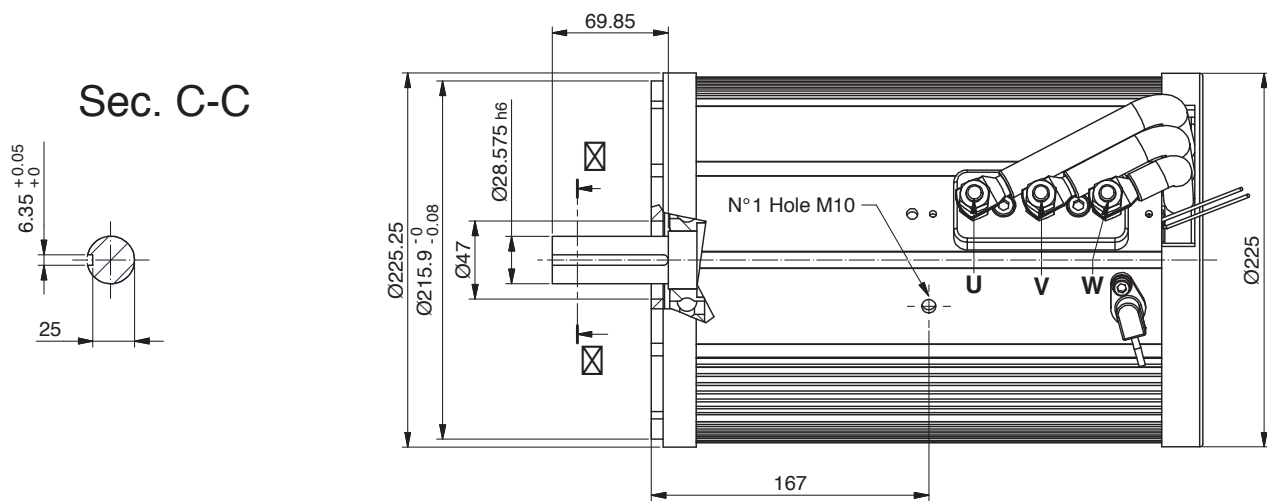
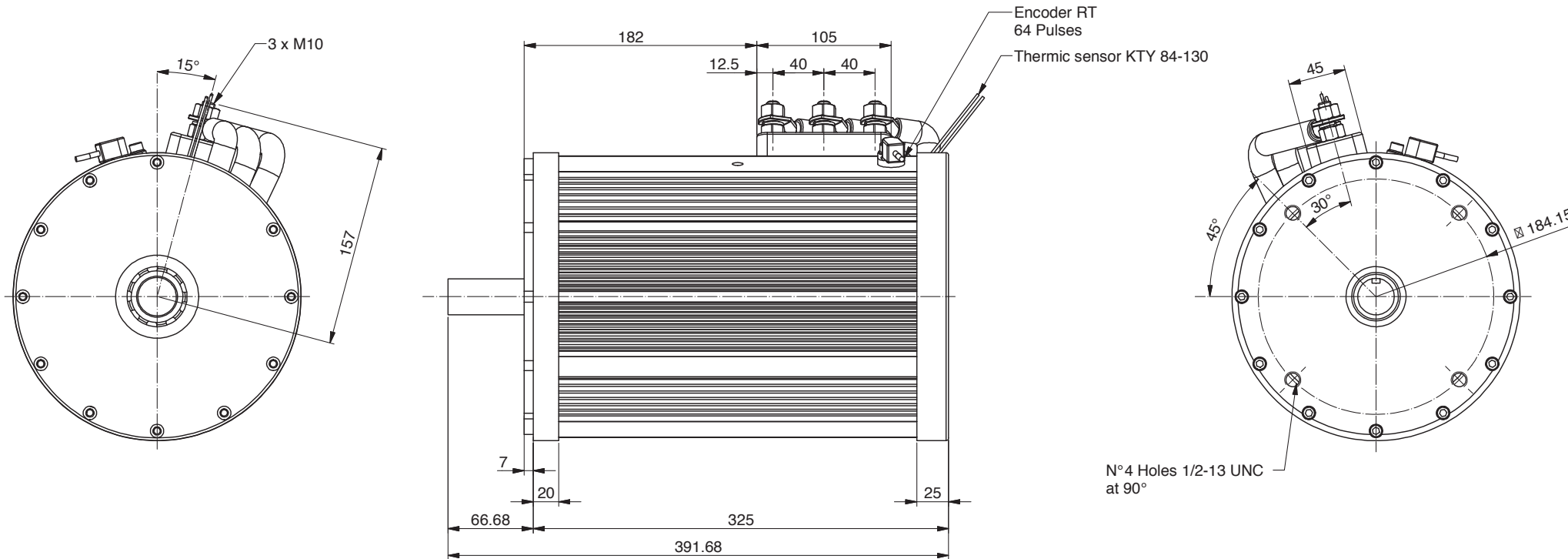

Power	6000 W
Tension	48 V
Speed	2500 Rpm
Torque	22.9 Nm
Enclosure	IP 20