

QUICK SELECTION / Selezione veloce

input speed (n₁) = 1400 min⁻¹

Output Speed n ₂ [min ⁻¹]	Ratio i	Motor power P _{1M} [kW]	Output torque M _{2M} [Nm]	Service factor f.s.	Nominal power P _{1R} [kW]	Nominal torque M _{2R} [Nm]	Available B5 motor flanges				Available B14 motor flanges			Dynamic efficiency RD	Tooth Module [mm]	Ratios code
							-B	-C	-D	-E	-Q	-R	-T			
							63	71	80	90	71	80	90			
22	62.9	0.75	248	1.2	0.87	286					C	C		77	3.10	01
18	78.5	0.75	293	1.0	0.73	286					C	C		73	2.41	02
15	94.2	0.75	333	0.9	0.70	310					C	C		69	2.10	03
11	126	0.55	297	1.0	0.55	296	B				C	C		63	1.53	04
9	157	0.37	230	1.1	0.41	252	B				C	C		58	1.23	05
8	185	0.37	257	1.2	0.43	296	B				C	C		55	3.10	06
6	231	0.25	193	1.5	0.38	296	B				C	C		49	2.41	07
5	277	0.25	222	1.3	0.33	296	B				C	C		47	2.10	08
4	378	0.18	200	1.5	0.27	296	B				C	C		43	2.10	09

A Motor Flanges Available
Flange Motore Disponibili

B Supplied with Reduction Bushing
Fornito con Bussola di Riduzione

B Available on Request without reduction bushing
Disponibile a Richiesta senza Bussola di Riduzione

C Motor Flange Holes Position
Posizione Fori Flangia Motore

* Power higher than the maximum one which can be supported by the gearbox. Select according to the torque M_{2R}
Potenza superiore a quella massima sopportabile dal riduttore. Selezionare in base al momento torcente M_{2R}

EN Unit P7Q is supplied with synthetic oil, providing "long life" lubrication. For mounting position V5-V6 please contact us. See table 1 for lubrication and recommended quantity. In table 2 please see possible radial loads and axial loads on the gearbox.

I Il riduttore tipo P7Q viene fornito lubrificato a vita con olio sintetico. Per posizioni V5-V6 contattare il ns. servizio tecnico. Vedi tab.1 per oli e quantità consigliati. In tab.2 sono presenti i carichi radiali e assiali applicabili al riduttore.

D Für die Lebensdauerschmierung ist das Getriebe der Größe P7Q mit synthetischem Öl befüllt. Bei Einbaulage V5 oder V6 bitten wir um Rücksprache. In Tabelle 1 ist die Schmiermenge und das empfohlene Schmiermittel angegeben. In Tabelle 2 sind die zulässigen Radial- und Axialbelastungen des Getriebes aufgeführt.

F Le réducteur de type P7Q est fourni lubrifié à vie avec de l'huile synthétique. Concernant les positions V5.V6, contactez notre service d'assistance technique. Voir tableau 1 concernant les huiles et les quantités conseillées. Les charges radiales et axiales applicables au réducteur sont précisées dans le tableau 2.

E El reductor tamaño P7Q se suministra, lubricado de por vida con aceite sintético. Para las posiciones V5 y V6 contactar con nuestro servicio técnico. Ver tabla 1, para cantidades y aceites recomendados. En la tabla 2, se encuentran las cargas radiales y axiales admitidas por el reductor.

LUBRICATION P7Q Oil

For B3-V5-V6 separate lubrication for A (0.40 l) B (0.14 l) , for B6-B7-B8 common lubrication 0.65 l (A + B).

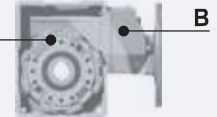

AGIP Telium VSF 320

SHELL Omala S4 WE 320

For all details on lubrication and plugs check our website **tab. 1**
Per maggiori dettagli su lubrificazione e tappi olio vedi il nostro sito web

RADIAL AND AXIAL LOADS

Output shaft

Albero di uscita

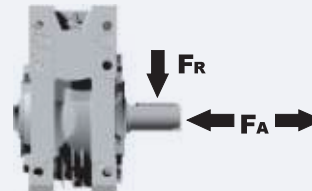

n ₂ [min ⁻¹]	FA [N]	FR [N]
75	620	3100
50	720	3600
25	880	4400
15-6	1000	5000

Input shaft

albero in entrata

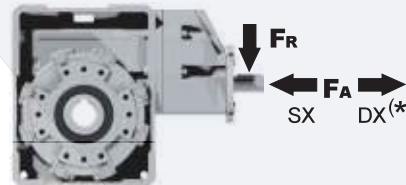

n [min ⁻¹]	FA [N]	FR [N]
1400	108	540

*Strong axial loads in the DX direction are not allowed.
Non sono consentiti forti carichi assiali con direzione DX

tab. 2

PP7QFB... Basic wormbox
Riduttore base

Gearbox weight
peso riduttore **9.90 kg**

M. flanges	Kit code	øF	A
63B5	K063.4.041	140	192.7
71B5	K063.4.042	160	190.7
80/90B5	K063.4.043	200	192.7
71B14	K063.4.047	105	190.7
80B14	K063.4.046	120	192.7
90B14	K063.4.041	140	192.7

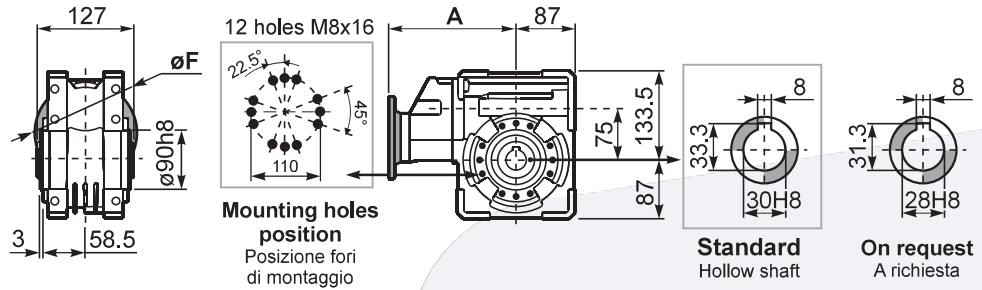

PP7QFC... Square flange
Flangia quadrata

PP7QFL... Square flange
Flangia quadrata

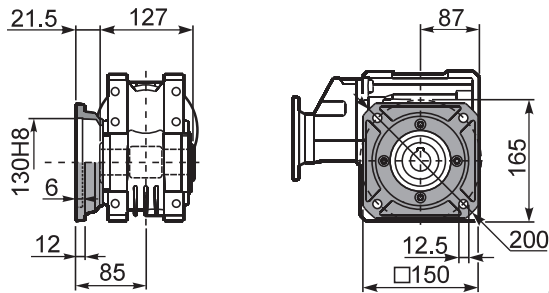

PP7QFB... Feet
Piedini

PP7QBR... Reaction arm
Braccio di reazione

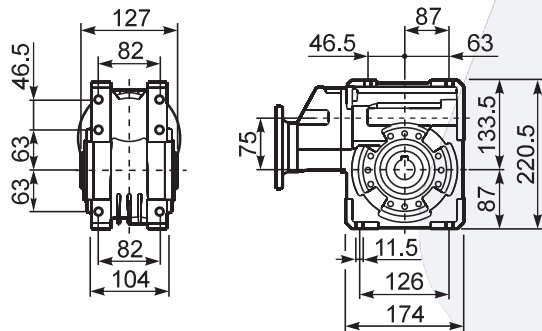

RP7QFB... Input shaft
Albero in entrata

PP7Q....S... Single Shaft
Albero lento semplice

PP7Q....D... Double Shaft
Albero lento bisp.

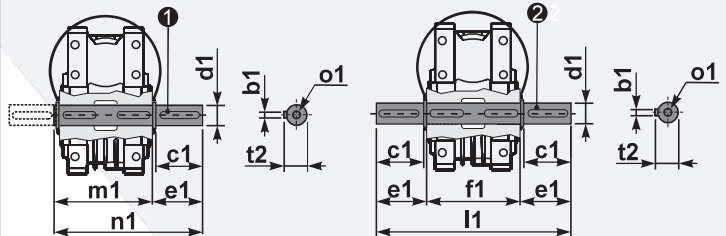
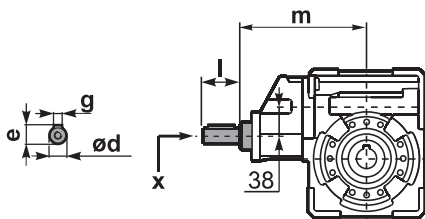

① kit cod. KQ75.5.028 Standard kit cod. KQ75.5.026 On request
② kit cod. KQ75.5.029 Standard kit cod. KQ75.5.027 On request

	ød	e	g	l	m	x	
type B	19 h6	21.5	6	35	185.5	M6x16	C40.5.062
type S	-	-	-	-	-	-	

	b1	c1	d1	e1	f1	l1	m1	n1	t2	o1
Standard	8	60	30 ^{-0.005} _{-0.020}	65	127	255	134	199	33	M8x20
On request	8	50	28 ^{-0.005} _{-0.020}	65	127	255	134	199	31	M8x20